



SCAFFOLD COUNT AND MESSAGE SHEET

COUNTRACT #

NOTE: OUTRIGGERS ARE REQUIRED WHEN HEIGHT MORE THAN 3 TIMES BASE WIDTH. HORIZONTAL BRACE IS REQUIRED AT BEGINNING OF EVERY 20 FT. OF TOWER HEIGHT. GUARD RAILS OR PANELS ARE REQUIRED ON PLATFORM MORE THAN 10 FT. ABOVE THE GROUND OR FLOOR. STATIONARY SCAFFOLDING MUST BE TIED TO STRUCTURE EVERY 25 FT. OF HEIGHT AS ERECTION PROCEEDS

ITEM DESCRIPTION	QUANTITY OUT	CUST. INITIAL	QUANTITY IN	CUST. INITIAL
END FRAME 5'X5'				
OTHER END FRAMES				
CROSS BRACE (X)				
PLANK- 10 FT.				
PLANK- 7 FT.				
CASTERS				
LEVELING JACKS				
BASE PLATE				
OUTRIGGERS				
GRAVITY PINS				
5 FT.GUARD PANEL				
10FT.GUARD PANEL				
GUARD RAIL POST				
5 FT.GUARD RAIL				
10FT.GUARD RAIL				
HORIZONTAL BRACE				

RECOMMENDED SCAFFOLDING ERECTION PROCEDURE

Introduction

This guide has been prepared by the Scaffolding, Shoring & Forming Institute to assist contractors, architects, engineers, dealers, erectors, and users, etc., for the proper use of scaffolding equipment. Scaffolding Safety Rules published by the Institute should be used in conjunction with this publication, as well as the instructions for the use of scaffolding provided by the manufacturer. Safety precautions and requirements prescribed by local, state, and federal agencies, including OSHA, must be followed at all times and persons working with scaffolding systems should be equipped with requisite safety devices.

Nomenclature

1. **Accessories**—Those items other than frames and braces used to facilitate the construction of scaffolding towers and structures.
2. **Adjustment Screw**—Device composed of a threaded screw and an adjusting handle used for the vertical adjustment of the scaffolding.
3. **Base Plate**—A device used to distribute the leg load.
4. **Climbing Ladders**—A separate ladder attached to the scaffolding structure or built into the scaffold frame.
5. **Casters**—Wheels of a suitable dimension and unit designed to attach to the base of a tower and containing a brake to prevent the wheels from rotating.
6. **Coupling Pin**—Device used to align and connect lifts or tiers together vertically.
7. **Cross-bracing**—System of members connecting frames or panels of scaffolding to make a tower structure.
8. **Extension Device**—Any device used to obtain vertical adjustment of scaffolding other than an adjustment screw.
9. **Factor of Safety**—the ratio of ultimate load to the allowable load.
10. **Frame or Panel+**—the principal prefabricated, welded structural unit.
11. **Guardrail**—A rail secured to uprights and erected along the exposed sides and ends of platforms.
12. **Horizontal Diagonal Bracing**—Diagonal braces running horizontally between frames of scaffolding.
13. **Lifts or Tiers+**—The number of frames stacked one above each other in a direction.
14. **Locking Device**—A device used to secure the cross brace to the panel.
15. **Putlog or Truss**—A separate horizontal load carrying member.
16. **Rolling Towers**—A composite structure of frames, braces, platforms, guardrails, and accessories supported by casters.
17. **Safe Leg Load**—That load which can safely be directly imposed on the frame leg.
18. **Safe Scaffold Frame Horizontal Member Load**—That load which can safely be directly imposed on a horizontal member.
19. **Scaffolding Layout**—An engineered drawing prepared prior to erection showing arrangement of equipment for proper scaffolding use.

20. **Side Bracket**—A cantilevered arm unit, supported by the scaffolding frame.
 21. **Sill or Mud Sill+**—A footing, usually wood, which distributes the vertical leg loads to the ground.
 22. **Ties**—A tension compression member used to securely attach scaffold to a structure.
 23. **Toeboard**—A barrier secured along the sides and ends of a platform, to guard against the falling of material.
 24. **Towers**—A composite structure of frames, braces, and accessories.
 25. **Ultimate Load**—The maximum load which may be placed on the scaffolding causing failure by buckling of column members or yielding of some component.
- + These terms can be used synonymously.

Inspection of Scaffolding Equipment Prior to Erection

The three main areas of inspection are for corrosion, straightness of members and welds. This applies to all components of a scaffolding system.

1. **CORROSION**—Heavily rusted or eroded scaffolding equipment is a telltale sign of abuse or neglect.
2. **STRAIGHTNESS OF MEMBERS**—Mishandling, trucking and storing may cause damage to scaffolding equipment. All scaffolding components should be straight and free from bends, kinks or dents.
3. **WELDS**—Equipment should be checked before use for damaged welds and any piece of equipment showing damaged welds or rewelding beyond the original factory weld should not be used. The factory weld reference pertains to location and quality of rewelds. While CORROSION, STRAIGHTNESS, and WELDS are of primary concern other component parts should be checked.
4. Locking devices on frames and braces shall be in good working order, and if not, must be repaired or replaced prior to use.
5. Coupling pins must effectively align the frame or panel legs.
6. Pivoted cross braces must have the center pivot securely in place.
7. Caster Brakes shall be in good working order and if not must be repaired or replaced prior to use.

Safe Bearing Loads for Soils

Considering that the allowable loads (bearing) on various soils and rock range from less than 1,000 p.s.f. to more than 50,000 p.s.f. care should be exercised in determining the capacity of the soil for every scaffolding job, realizing that weather conditions can turn an otherwise suitable ground condition into a hazardous situation. As an example, dry clay with an allowable bearing capacity of 8,000 p.s.f. could become very plastic after a rainfall and drop to less than 2,000 p.s.f.

Care should also be taken not to excessively disturb the soil. If fill is required in areas where scaffolding is used, a qualified engineer should be consulted as to materials and compaction.

Foundations

The purpose of a good foundation or mud sill is to distribute the scaffolding load over a suitable ground area. The size of the footing or sill is determined by the total load carried over a particular ground area, and by the nature of the soil supporting these sills.

The total load should be computed and the sills designed accordingly.

When scaffolding from earth or fill, the areas should be leveled and the sills spaced in a pattern assuring adequate stability for all scaffolding legs.

Erection of Frames

The work of erecting the scaffolding should be under the supervision of a person with proper experience and aptitude for securing a safe installation and who is familiar with all Local, State and Federal Regulations concerning scaffolding, as well as the SSFI Scaffolding Safety Rules.

It shall be the responsibility of the person supervising the erection of the scaffold to see that all components and locking devices are in working order, and no damaged or deteriorated equipment is used in the setup. Should any scaffolding become damaged after the equipment has been erected, workmen shall not be allowed on same until the damaged items have been repaired or replaced.

Advanced planning will help the erection of scaffolding to progress smoothly. The equipment should be unloaded as close to the area of use as possible and should be arranged in the order it is to be used. Adjustment screws should be set to their approximate final adjustment before setting up the scaffolding. At this time, a person should check to see that all panels which require coupling pins have them. Consult safety rules as recommended by the Institute.

After erecting the first tier of scaffold frames, plumb and level (using instruments) all frames so that no matter how high the final scaffolding setup, the additional frames will also be in correct alignment.

As erection proceeds, securely tie all scaffolding to the structure at the ends and at least every 30' horizontally, and at height intervals not to exceed* 4 times the minimum base dimension. Free standing scaffold towers must be restrained from tipping by guying or other means. Scaffold frames must be fastened together at coupling pins where there is a possibility of uplift.

When scaffolds are to be partially or fully enclosed, specific precautions must be taken to assure frequency adequacy of ties attaching the scaffolding to the building due to increased load conditions resulting from effects of wind and weather. The scaffolding components to which the ties are attached must also be checked for additional loads.

When erecting additional lifts, always work from planking placed within the scaffold structure. Move planking as erection progresses.

Planking and Accessories

Use only lumber that is properly inspected and graded for use as scaffold plank.

Planking shall have at least 12" of overlap and extend 6" beyond center of support or be cleated at both ends to prevent sliding off support. Do not allow unsupported ends of plank to extend beyond supports. Secure plank to scaffolding when necessary.

All scaffold accessories shall be used and installed in accordance with the manufacturer's recommended procedures. Accessories shall not be altered in the field.

When installing hanger or clamp supported putlogs (trusses), care should be taken to see that they extend at least 6" beyond the point of support. Also, make sure that the proper bracing is placed between putlogs (trusses). When the span between supporting members is more than 12' additional bracing between the putlogs (trusses) and the supporting member may be required. Do not cantilever or extend putlogs (trusses) as side brackets without thorough consideration for loads to be applied or transmitted to the scaffold. When clamping putlogs, clamp capacity may control rather than putlog capacity. Consult scaffold manufacturer.

All brackets should be seated correctly with side brackets parallel to the frames and the end brackets at 90 degrees to the frame. Brackets shall not be bent or twisted from normal position.

Equip all planked or staged areas with proper guard rails and add toeboards when required.

Final and Daily Inspection of Erected Scaffolding

The following is a list of check points to be covered when making a final and daily inspection of scaffolding prior to use. All points should be carefully checked to insure a safe and accident-free job and be periodically rechecked.

1. Check to see that there is proper support under every leg of every frame on the job. Check also for possible washout due to rain.
2. Check to make certain that all base plates and adjustment screws are in firm contact with their supports. All adjustment nuts should be snug against the legs of the frame.
3. Frames should be checked for plumbness in both directions.
4. If there is a gap between the lower end of one frame and the upper end of another frame it indicates that one adjustment screw must be adjusted to bring the frames in contact. If this does not help it indicates the frame is out of square and should be replaced.
5. Each leg of each frame should be cross braced to the corresponding leg of the next frame.
6. While checking the cross braces also check the locking devices to assure that they are all in their closed position or that they are all tight.
7. Check to be certain that all planking and accessories are properly installed.
8. Check to make certain all ties are secured between the structure and the scaffolding.

9. Check to be certain all guard rails are in place.
10. If scaffolding is enclosed, check to see that additional precautions have been taken as noted in Section of Erection. Recheck periodically ties, clamps, etc., for movement.
11. Insure that safe access to work platform(s) is provided.

Dismantling of Scaffolding

The work of dismantling scaffolding should be under the supervision of an individual with proper experience and aptitude. The following should be observed while dismantling.

1. Check to see if scaffolding has been structurally altered in any way which would make it unsafe, and if so reconstruct where necessary before commencing with the dismantling procedures.
2. Dismantle scaffold from the top down. Begin by removing all accessories from that lift being dismantled at the time.
3. Always work from a minimum of two plank placed on the tier of frames below those being removed. Move the planking down as dismantling progresses.
4. Do not remove ties until dismantling has reached the tier to which they are attached.
5. Always stay within the inside of the scaffold. Do not climb on the outside for any reason when dismantling. Do not climb on ties, braces or unbraced frames.
6. Only remove fastening devices from bottom of frames being removed.
7. Lower scaffolding components in a safe manner as they are dismantled. Avoid dropping or throwing the components as this could result in damage to the equipment, or injury to personnel below.

Erection of Rolling Towers

When erecting rolling scaffolding towers, the following additional items apply. These items are in addition to the application portions of the preceding section.

1. Caster should be of adequate load capacity and size in relation to the height of the tower, the surface over which the tower is to be used and in accordance with all government, state, and local codes, ordinances, and regulations.
Casters with plain stems shall be attached to the panel or adjustment screw by pins or other suitable means.
2. Do not extend adjusting screws on rolling towers more than 12".
3. The platform height shall not exceed* four (4) times the smallest base dimension unless guyed or otherwise stabilized.
4. Horizontal diagonal braces should be used near the bottom, top and at 20' intervals measured from the rolling surface.
5. When side brackets are used, consideration should be given to the overturning effect these brackets will have upon the stability of the tower.
6. Cross brace every lift-both sides.
7. Install guardrails.

8. Plank according to Plank and Accessories Section of Erection Procedure.

* EXCEPTIONS: Three times in California, Ohio, Oregon, Montana, Maine; 3-1/2 times in Washington.

Final Inspection of Rolling Towers

The following additional points should be checked when making a final inspection of rolling scaffold towers prior to their use. These points are in addition to the applicable items covered under the preceding section entitled, "Final Inspection of Erected Scaffolding."

1. Check to see that the platform height does not exceed* four (4) times the smallest base dimension unless the tower is properly guyed or otherwise stabilized.
2. Check to see that, if adjusting screws have been used, they are not extended more than 12".
3. Check to make sure the caster brakes are in good working condition and are applied when tower is not being moved.
4. Inspect to make sure horizontal diagonal bracing has been placed near the bottom, top, and at 20' intervals measured from the rolling surface. A hook on manufactured platform properly attached to the top frame may be equivalent to the top horizontal diagonal brace.
5. Cross bracing has been installed on both sides of every lift.
6. Check the area in which the tower is to be used to insure there are no obstructions either in, on, or above the floor which will interfere with the proper and safe use of the rolling tower.
7. Check for guardrails.
8. Check to see that all planks and fabricated platforms are properly installed.
9. Insure that safe access to work platform(s) is provided.

REFER TO SCAFFOLDING, SHORING & FORMING INSTITUTE SCAFFOLDING SAFETY RULES BEFORE USING SCAFFOLDING.

The procedures outlined in this Guide describe conventional procedures for erecting and dismantling scaffolding systems. However, equipment and systems differ and, accordingly, reference must always be made to the instructions and procedures of the manufacturer or supplier of the equipment. Since field conditions vary and are beyond the control of the Institute and its members, safe and proper use of this equipment is the responsibility of the user and not the Institute or its members.

**SCAFFOLDING AND SHORING INSTITUTE
1230 KEITH BUILDING
CLEVELAND, OHIO 44115**

BIL-JAX[®]

**125 TAYLOR PARKWAY
ARCHBOLD, OHIO 43502**

SCAFFOLDING SAFETY GUIDELINES

as Recommended by SCAFFOLDING, SHORING & FORMING INSTITUTE

It shall be the responsibility of all employers and employees to read and comply with the following common sense guidelines which are designed to promote safety in the erecting and dismantling of scaffolds. These guidelines do not purport to be all-inclusive nor to supplant or replace other additional safety and precautionary measures to cover usual or unusual conditions. Local, State or Federal statute or regulations shall supersede these guidelines if there is a conflict and it is the responsibility of each employee to comply.

GENERAL GUIDELINES

- I. POST THESE SCAFFOLDING SAFETY GUIDELINES** in a conspicuous place and be sure that all persons who erect, dismantle or use scaffolding are aware of them.
- II. FOLLOW ALL STATE, LOCAL AND FEDERAL CODES, ORDINANCES AND REGULATIONS** pertaining to scaffolding because they may be more restrictive. For example, height or width requirements may vary.
- III. SURVEY THE JOB SITE**—A survey shall be made of the job site for hazards, such as untamped earth fills, ditches, debris, high tension wires, unguarded openings, and other hazardous conditions created by other trades. These conditions shall be corrected or avoided as noted in the following sections.
- IV. INSPECT ALL EQUIPMENT BEFORE USING**—Never use any equipment that is damaged or defective in any way.
- V. KEEP ALL EQUIPMENT IN GOOD REPAIR**—Avoid using corroded equipment—the strength of corroded equipment is not known.
- VI. INSPECT ERECTED SCAFFOLDS DAILY**—or at the beginning of every shift to be sure that they are maintained in safe condition.
- VII. NEVER USE EQUIPMENT FOR PURPOSES OR IN WAYS FOR WHICH IT WAS NOT INTENDED.**
- VIII. REPORT ANY UNSAFE CONDITION. NEVER TAKE CHANCES**—Do not work on scaffolds if your physical condition is such that you feel dizzy or unsteady in any way.
- IX. WORKING UNDER THE INFLUENCE OF ALCOHOL OR ILLEGAL DRUGS IS STRICTLY PROHIBITED.**
- X. CONSULT YOUR SCAFFOLDING SUPPLIER—NEVER TAKE CHANCES**—Consult manuals and instructions provided by the supplier; scaffolding is his business.

GUIDELINES FOR ERECTION AND USE OF SCAFFOLDS

- A. PROVIDE ADEQUATE SILLS for scaffold posts and use base plates.
- B. USE ADJUSTING SCREWS for other approved conditions.
- C. PLUMB AND LEVEL ALL SCAFFOLDS as the erection proceeds. Do not force braces to fit—level the scaffold until proper fit can be made easily.
- D. BRACING. Each frame or panel shall be braced by horizontal bracing, cross bracing, diagonal bracing or any combination thereof for securing vertical members together laterally. All brace connections shall be made secure, in accordance with manufacturers' recommendations.
- E. DO NOT CLIMB CROSS BRACES. Use only an access (climbing) ladder, access steps, frame designed to be climbed or equivalent safe access to scaffold.
- F. TIE RUNNING SCAFFOLD TO WALL or structure when the height exceeds* four (4) times the minimum scaffold base dimension. The first vertical and longitudinal tie shall be placed at this point. Vertical ties shall be repeated at intervals not greater than 26 feet. Longitudinal ties shall be placed at each end and at intervals not greater than 30 feet. Ties must prevent the scaffold from tipping into or away from the wall or structure.
- G. WHEN SCAFFOLDS ARE TO BE PARTIALLY OR FULLY ENCLOSED, specific precautions must be taken to assure frequency and adequacy of ties attaching the scaffolding to the building due to increased load conditions resulting from effects of wind and weather. The scaffolding components to which the ties are attached must also be checked for additional loads.
- H. WHEN FREE STANDING SCAFFOLD TOWERS exceed* four times their minimum base dimension vertically, they must be restrained from tipping.
- I. DO NOT ERECT SCAFFOLDS NEAR ELECTRICAL POWER LINES UNLESS PROPER PRECAUTIONS ARE TAKEN. Consult the power service company for advice.
- J. DO NOT USE ladders or makeshift devices on top of scaffolds to increase the height.
- K. DO NOT EXCEED MANUFACTURERS' RECOMMENDED LOAD RATING.
- L. EQUIP AND MAINTAIN ALL PLATFORMS with proper guardrails, mid-rails, and toeboards along all open sides and ends of scaffold platforms.
- M. ALL BRACKETS shall be seated correctly with side brackets parallel to the frames and end brackets at 90 degrees to the frames. Brackets shall not be bent or twisted from normal position. Brackets (except mobile brackets designed to carry materials) are to be used as work platforms only and shall not be used for storage of material or equipment. When brackets are used, the scaffold shall be tied to the structure or otherwise restrained to prevent tipping.
- N. ALL SCAFFOLDING ACCESSORIES shall be used and installed in accordance with the manufacturers' recommended procedure. Accessories shall not be altered in the field. Scaffolds, frames and their components of various manufacturers shall not be intermixed.
- O. FOR PLANKING, THE FOLLOWING GUIDELINES APPLY:
 1. Use only lumber that is properly inspected and graded as scaffold plank.
 2. Planking shall have at least 12 inches of overlap and extend 6 inches beyond center of support, or, be cleated at both ends to prevent sliding off supports.
 3. Fabricated scaffold planks and platforms, unless created or restrained by hooks, shall extend over their end supports not less than 6 inches nor more than 12 inches.
 4. Secure plank to scaffold when necessary.
- P. FOR ROLLING SCAFFOLDS THE FOLLOWING ADDITIONAL GUIDELINES APPLY:
 1. CASTERS WITH PLAIN STEMS shall be attached to the panel or adjustment screw by pins or other suitable means.
 2. DO NOT EXTEND ADJUSTING SCREWS ON ROLLING SCAFFOLDS MORE THAN 12 INCHES.
 3. WHEELS OR CASTERS shall be provided with a locking device and kept locked during erection and dismantling or any time scaffolds are not being moved.
 4. SECURE OR REMOVE ALL MATERIAL AND EQUIPMENT from platform before moving scaffold.
 5. USE HORIZONTAL DIAGONAL BRACING near the bottom and at 20 foot intervals measured from the rolling surface.
 6. DO NOT USE brackets or other platform extensions without consideration of overturning effect.
 7. THE HEIGHT OF A ROLLING SCAFFOLD excluding its uppermost guardrails, must not exceed* four times its smallest base dimension unless it is stabilized by an engineered counterweight system or some other equivalent means.
 8. CLEAT OR SECURE ALL PLANKS.
 9. DO NOT ATTEMPT TO MOVE A ROLLING SCAFFOLD WITHOUT SUFFICIENT HELP—watch out for holes in floor and overhead obstructions—stabilize against tipping.
 10. DO NOT RIDE ROLLING SCAFFOLDS.
 11. JOINTS shall be restrained from separation.
- Q. FOR "PUTLOGS" AND "TRUSSES" the following additional guidelines apply:
 1. DO NOT CANTILEVER OR EXTEND PUTLOGS/TRUSSES as side brackets without thorough consideration for loads to be applied.
 2. PUTLOGS/TRUSSES SHOULD BE EXTENDED AT LEAST 6 inches beyond point of support.
 3. PLACE RECOMMENDED BRACING BETWEEN PUTLOGS/TRUSSES when the span of putlog/truss is more than 12 feet.
- R. WHEN DISMANTLING SCAFFOLDING THE FOLLOWING ADDITIONAL GUIDELINES APPLY:
 1. CHECK TO SEE IF SCAFFOLDING HAS BEEN STRUCTURALLY ALTERED in any way which would make it unsafe, and if so, reconstruct where necessary before commencing with dismantling procedures.
 2. VISUALLY INSPECT PLANK prior to dismantling to be sure that they are safe to work on.
 3. COMPONENTS SHOULD BE LOWERED as soon as dismantled in safe manner so as to protect personnel below.
 4. DO NOT ACCUMULATE EXCESS COMPONENTS OR EQUIPMENT on the level being dismantled.
 5. DISMANTLED EQUIPMENT should be stockpiled in an orderly manner.
- S. FOLLOW ERECTION PROCEDURES AND USE MANUALS.

* EXCEPTIONS: Three times in California, Ohio, Oregon, Montana, Maine; 3-1/2 times in Washington.

"These safety guidelines set forth common sense procedures for safely erecting and dismantling scaffolding equipment. However, equipment and scaffolding systems differ, and accordingly, reference must always be made to the instructions and procedures of the supplier of the equipment. Since field conditions vary and are beyond the control of the Institute, safe and proper use of scaffolding is the responsibility of the user and not the Institute."

Reprinting of this publication does not imply approval of product by the Institute or indicate membership in the Institute. Permission to reproduce in entirety can be obtained from Scaffolding, Shoring & Forming Institute, 1230 Keith Bldg., Cleveland, Ohio 44115

INSTRUCTIONS FOR ERECTING ROLLING OR STATIONARY TOWERS

Bil-Jax, Inc. recommends that all users of this equipment be supplied with safety information and OSHA rules and regulations. This information must be thoroughly read and understood before using the equipment. If you have not been provided with OSHA regulations or safety literature, please call 419/445-8915 before use.

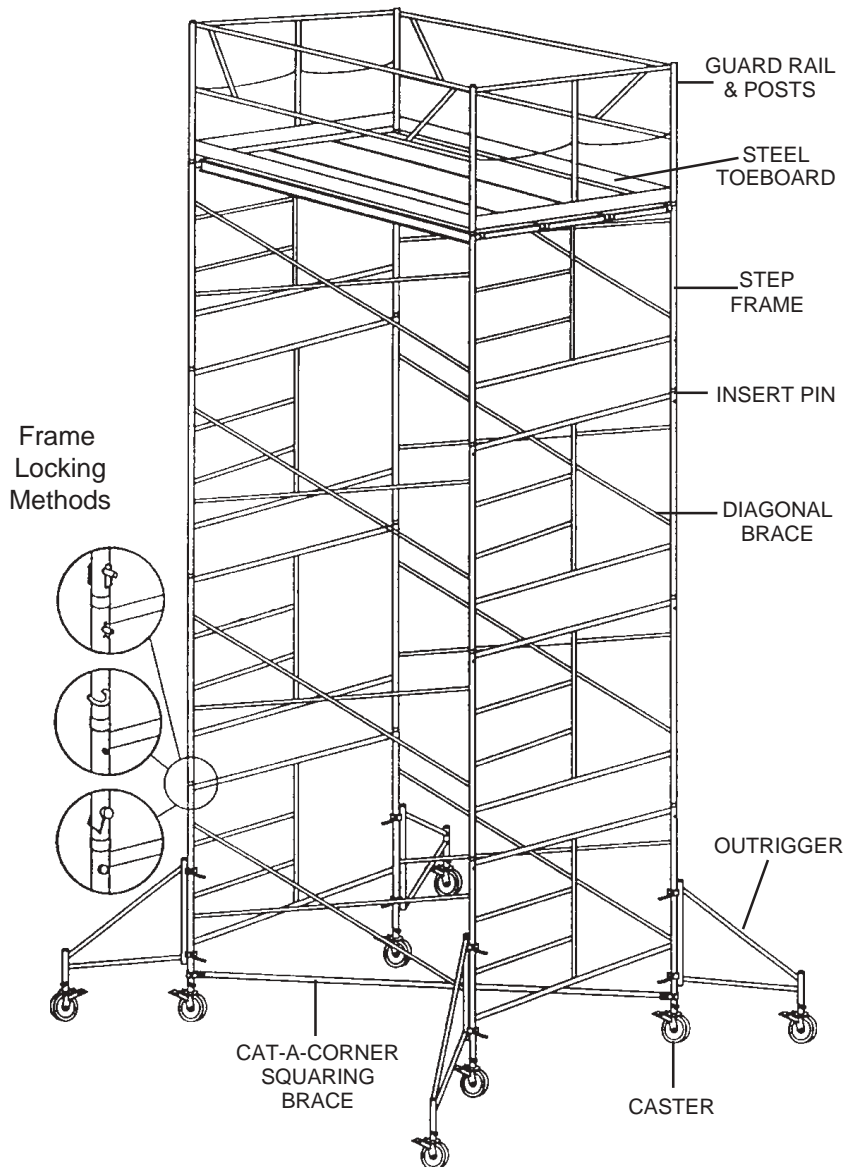

Bil-Jax Rolling Towers offer large work platform areas and adjustable platform levels, while providing workers with a quick, easy and safe assembly.

A Rolling Tower should only be used on solid, level and clear floor areas. Do not use on soil or unlevel surfaces. Check for overhead obstructions which may interfere with the tower.

NOTE: Some areas may require separate access ladders or stairs. Consult your local authorities for information before beginning scaffold erection.

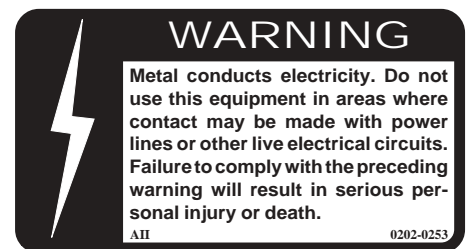

1. Before starting scaffold erection, check all parts for damage, making sure that they are in proper working order. Any part that does not look to be in good working condition or is damaged in any way should not be used.

BRACING

2. Attach diagonal bracing to frame sections, securing in place with the frame brace locks (Fig. 1).

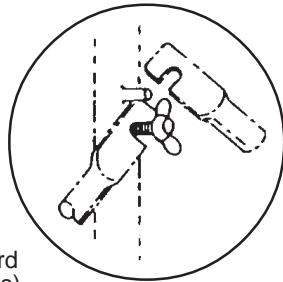

Fig. 1
J-LOCK (Standard
w/Notched Braces)

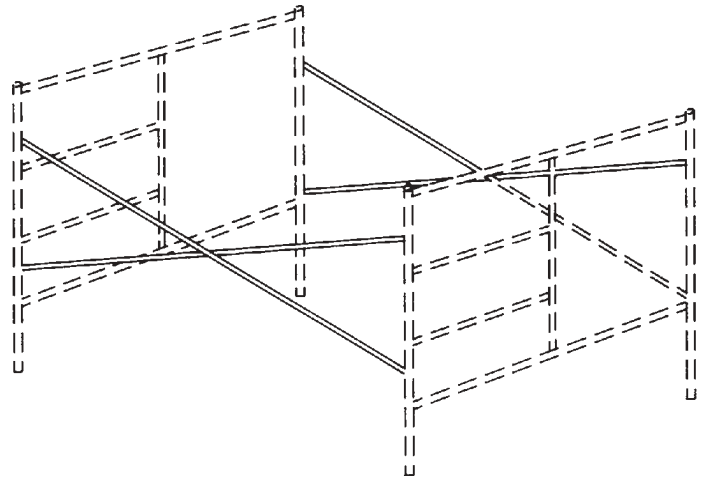

Fig. 2

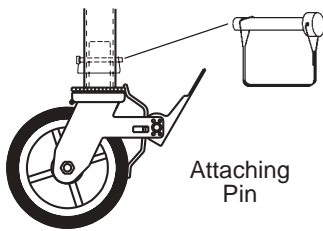
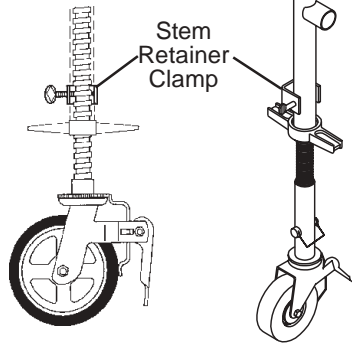

Fig. 3



CASTERS, JACKS, BASE PLATES

3. Insert casters and secure with attaching pin or bolt. Set brakes on all casters (Fig. 2) before proceeding with tower erection. If leveling casters or extensions are used, secure with stem retainer clamp, wire, or other suitable means (Fig. 3). Do not extend leveling screws more than 12". If application does not call for a Rolling Tower, follow above procedure and replace casters with leveling jacks (Fig. 4) or base plates (Fig. 5) on mud sills.

Fig. 4

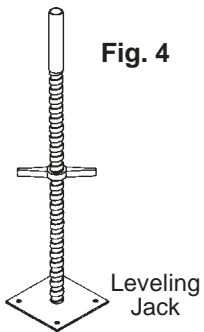
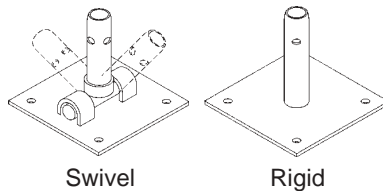
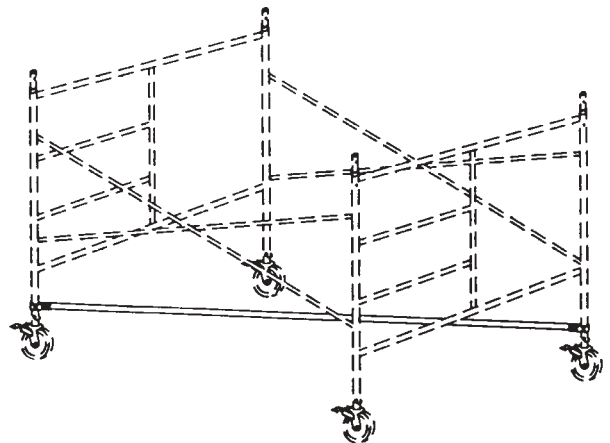
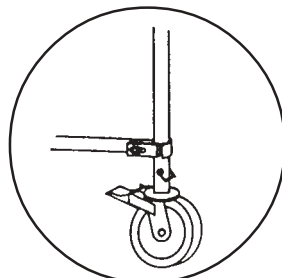

Fig. 5



CAT-A-CORNER SQUARING BRACE

4. Install cat-a-corner squaring brace (this should be installed at the base and every additional 20' of height).



OUTRIGGERS

- Determine tower height required to complete the job. If height exceeds 3 times the minimum base dimension, (see Free Standing Tower Height section below) install outriggers to increase minimum base dimension or tie in to permanent structure as codes require. Pin caster to outrigger and attach outrigger to scaffold leg. Adjust to desired angle and tighten clamp firmly to prevent movement. Set caster brakes.

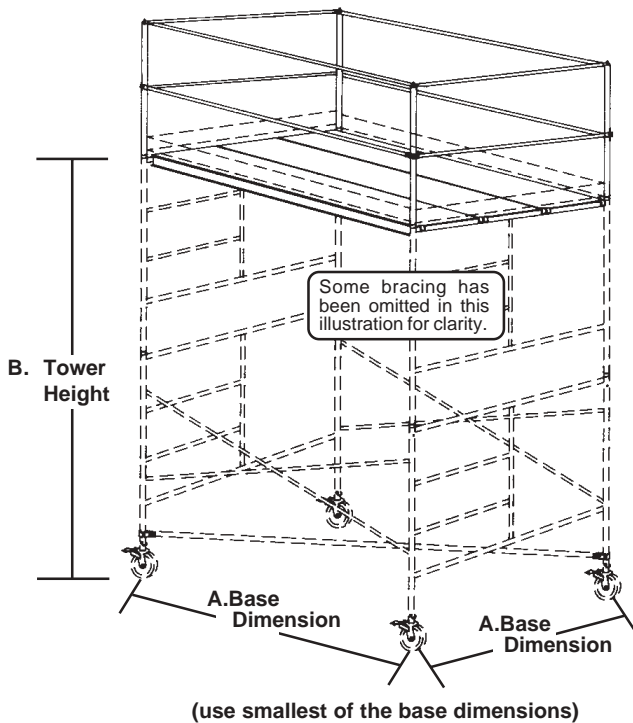
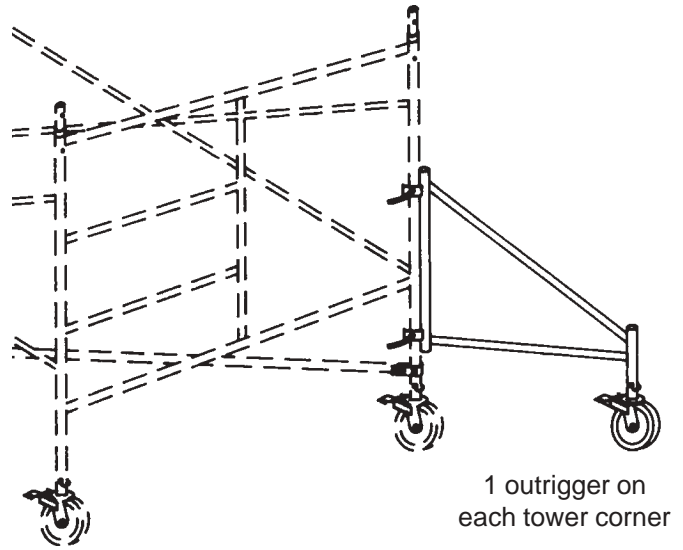

Bil-Jax, Inc. recommends the maximum free-standing tower height permitted for a Rolling Tower be 3 times the minimum base dimension, although OSHA codes allow 4 to 1 in most states. Consult your state and local codes to insure your tower complies with all applicable regulations.

$$A \times 3 = B$$

(smallest base dimension) (some states allow 3-1/2 or 4—check your local & state codes) (maximum tower height permitted)

ADDING FRAME SECTIONS

- Hoist end frames and braces to next level by means of rope and tag line. Install diagonal bracing. Secure frames together using inserts and insert locking pins. Be sure to erect step frames so that the steps continue above one another on the same side of the frame. Full decking should be installed on completed tier before attempting to assemble next tier, and should be moved up as each additional tier is completed.

NOTE: When required, access ladder or stair sections must be installed at the same time as each scaffold section is added.

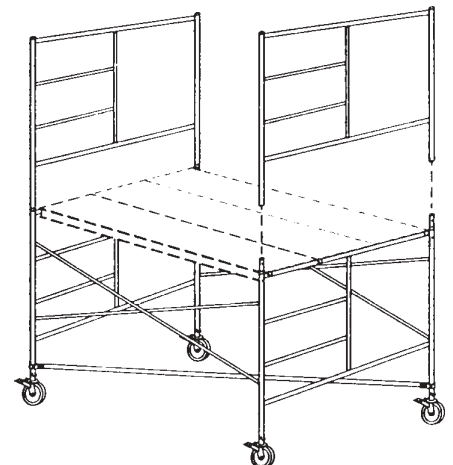

All photos and drawings are for illustration only. Always concerned with the improvement of the quality of this product, the manufacturer reserves the right to modify specifications without prior notice. Follow all applicable ANSI and OSHA Codes and Regulations for use of this equipment. Do not use this product in areas where user can come in contact with live power.

GUARD RAILING - FINAL DECKING

7. Upon completion of tower to desired height, install and lock double guard railing and toeboards on all 4 sides as required by OSHA. Make sure all guard rail posts are secured with lock pins. Install walkboards to fully deck platform work area. Secure walkboards in place by using an 8 penny nail (Fig. 6), engaging slide lock (Fig. 7), engaging rotation lock (Fig. 8), as equipped. See OSHA regulations for additional information concerning securing decking.

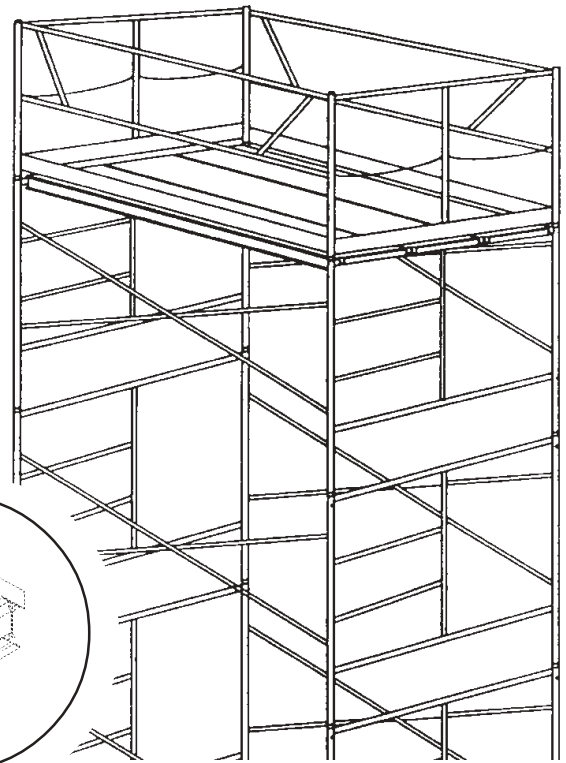
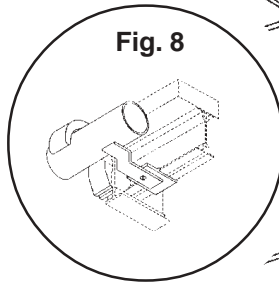
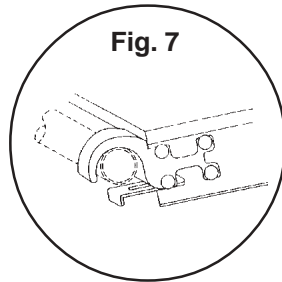
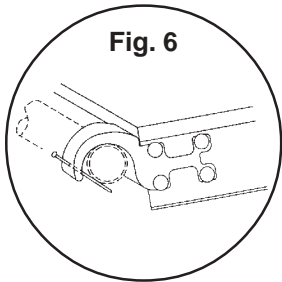

IMPORTANT: CAUTION

- Inspect scaffold daily or before each use.
- Do not exert horizontal force from on top of a free-standing scaffold.
- Do not climb or stand on cross braces or horizontal braces.
- Do not swing around corner of scaffold to enter platform from the cross brace side.
- Do not use boxes, ladders, or other means to increase working height.
- Do not stand or sit on guard rails.
- Do not use bricks, boxes, concrete blocks, or any other unstable objects under scaffold leg.
- **NEVER** ride a moving scaffold.
- Do not move scaffold by applying a pulling or pushing force at or near the top.
- Do not use braces as a platform support.
- Do not use personnel brackets (side brackets) on a Rolling Tower.
- Use approved access ladder or stairs to climb scaffold. Properly erected step type end frames will provide "equivalent, safe access" as required by OSHA.
- When hoisting material or using side brackets, scaffold must be restrained from tipping by guying, tying to a permanent structure or other acceptable means.
- Restrict loading to safe working loads. If unsure of safe load limit, consult your scaffold dealer.
- If you have not been provided with OSHA regulations or safety literature, or for any questions concerning the safe use of this equipment, call 419/445-8915 before use.

NOTE: All OSHA, state and local codes and regulations pertaining to this equipment should be obtained, read, and thoroughly understood before attempting to erect or use this equipment. Persons under the influence of drugs, alcohol, or prescription medication should not be on or near this equipment. Common sense should be implemented at all times during the erection and use of this equipment. **DO NOT USE THIS EQUIPMENT IN AREAS WHERE EQUIPMENT OR USER MAY COME IN CONTACT WITH LIVE POWER SOURCE.**

BIL-JAX[®]

125 Taylor Parkway Archbold, OH 43502-9309
Phone 419-445-8915 • 800-537-0540
Fax 419-445-0367